

SOT-323 Plastic-Encapsulate MOSFETS

MMBT7002W MOSFET (N-Channel)

$V_{(BR)DSS}$	$R_{DS(on)MAX}$	I_D
60V	5Ω@10V	115mA
	7Ω@5V	

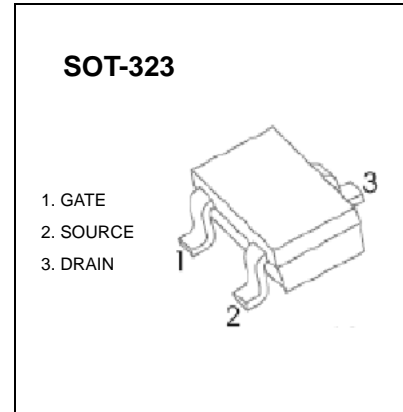

FEATURE

- High density cell design for low $R_{DS(ON)}$
- Voltage controlled small signal switch
- Rugged and reliable
- High saturation current capability

APPLICATION

- Load Switch for Portable Devices
- DC/DC Converter

Equivalent Circuit

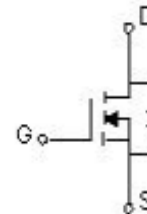

MAXIMUM RATINGS ($T_a=25^{\circ}C$ unless otherwise noted)

Parameter	Symbol	Value	Unit
Drain-Source Voltage	V_{DS}	60	V
Gate-Source Voltage	V_{GS}	20	V
Continuous Drain Current	I_D	0.115	A
Power Dissipation	P_D	0.200	W
Thermal Resistance from Junction to Ambient	$R_{\theta JA}$	625	$^{\circ}C/W$
Junction Temperature	T_J	150	$^{\circ}C$
Storage Temperature	T_{stg}	-50 ~ +150	

MOSFET ELECTRICAL CHARACTERISTICS

$T_a=25\text{ }^\circ\text{C}$ unless otherwise specified

Parameter	Symbol	Test conditions	Min	Typ	Max	Unit
Drain-Source Breakdown Voltage	$V_{(BR)DSS}$	$V_{GS}=0\text{ V}, I_D=250\text{ }\mu\text{A}$	60			V
Gate-Threshold Voltage	$V_{(GS)th}$	$V_{DS}=V_{GS}, I_D=250\text{ }\mu\text{A}$	1	1.6	2.5	
Gate-body Leakage	I_{GSS}	$V_{DS}=0\text{ V}, V_{GS}=\pm 20\text{ V}$			± 80	nA
Zero Gate Voltage Drain Current	I_{DSS}	$V_{DS}=60\text{ V}, V_{GS}=0\text{ V}$			80	nA
On-state Drain Current	$I_{D(on)}$	$V_{GS}=10\text{ V}, V_{DS}=7\text{ V}$	500			mA
Drain-Source On-Resistance	$R_{DS(on)}$	$V_{GS}=10\text{ V}, I_D=500\text{ mA}$		0.9	5	Ω
		$V_{GS}=5\text{ V}, I_D=50\text{ mA}$		1.1	7	
Forward Trans conductance	g_{fs}	$V_{DS}=10\text{ V}, I_D=200\text{ mA}$	80			ms
Drain-source on-voltage	$V_{DS(on)}$	$V_{GS}=10\text{ V}, I_D=500\text{ mA}$			3.75	V
		$V_{GS}=5\text{ V}, I_D=50\text{ mA}$			0.375	V
Diode Forward Voltage	V_{SD}	$I_S=115\text{ mA}, V_{GS}=0\text{ V}$	0.55		1.2	V
Input Capacitance *	C_{iss}	$V_{DS}=25\text{ V}, V_{GS}=0\text{ V}, f=1\text{ MHz}$			50	pF
Output Capacitance *	C_{oss}				25	
Reverse Transfer Capacitance*	C_{rss}				5	

SWITCHING TIME

Turn-on Time*	$t_{d(on)}$	$V_{DD}=25\text{ V}, R_L=50\Omega,$ $I_D=500\text{ mA}, V_{GEN}=10\text{ V}$ $R_G=25\Omega$			20	ns
Turn-off Time*	$t_{d(off)}$				40	

*These parameters have no way to verify.

Typical Characteristics

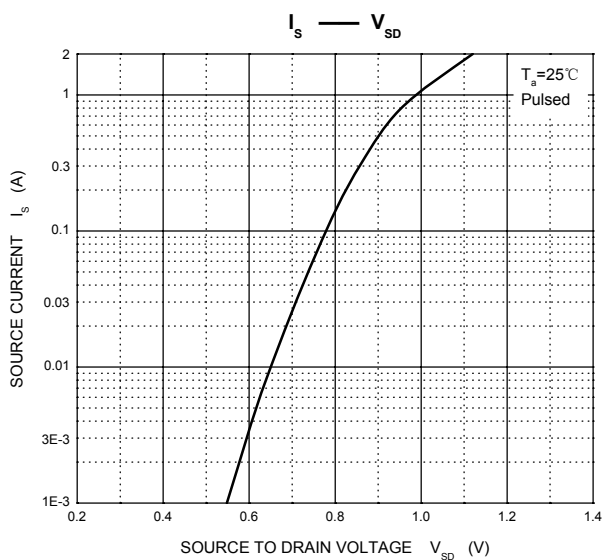
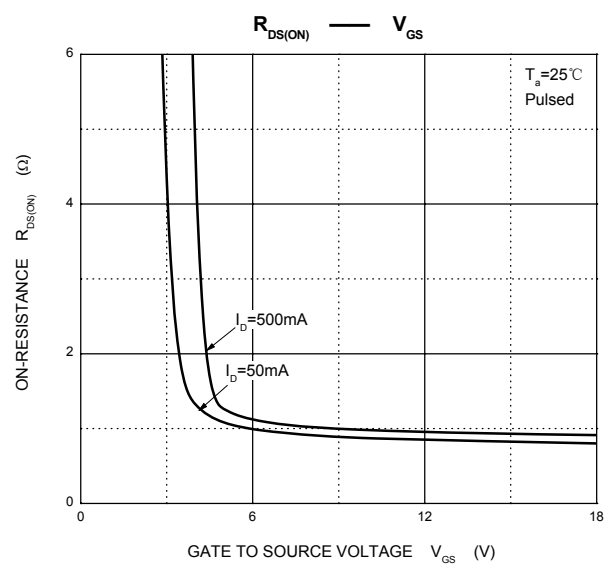
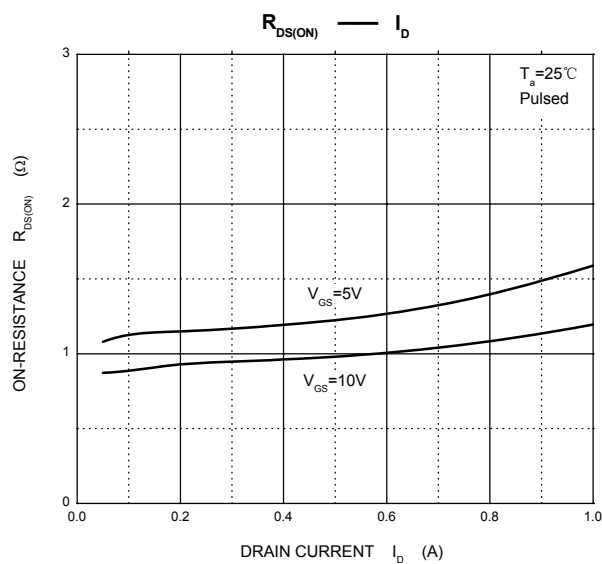
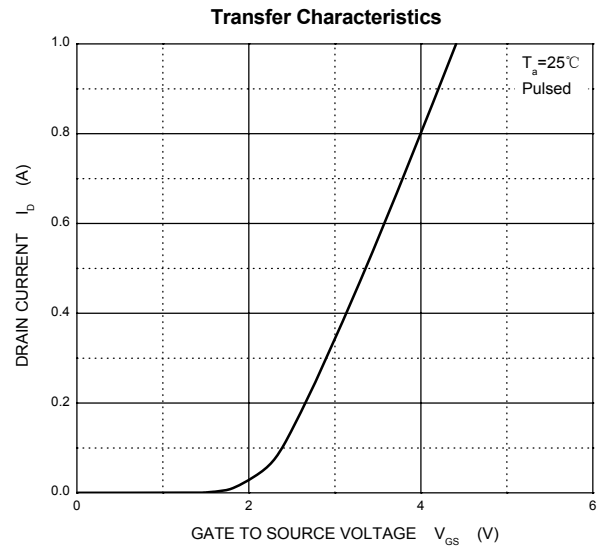
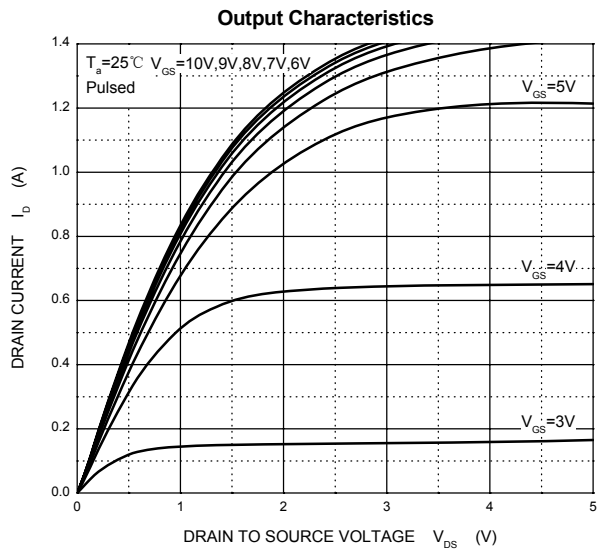

SOT-323 PACKAGE OUTLINE DIMENSIONS

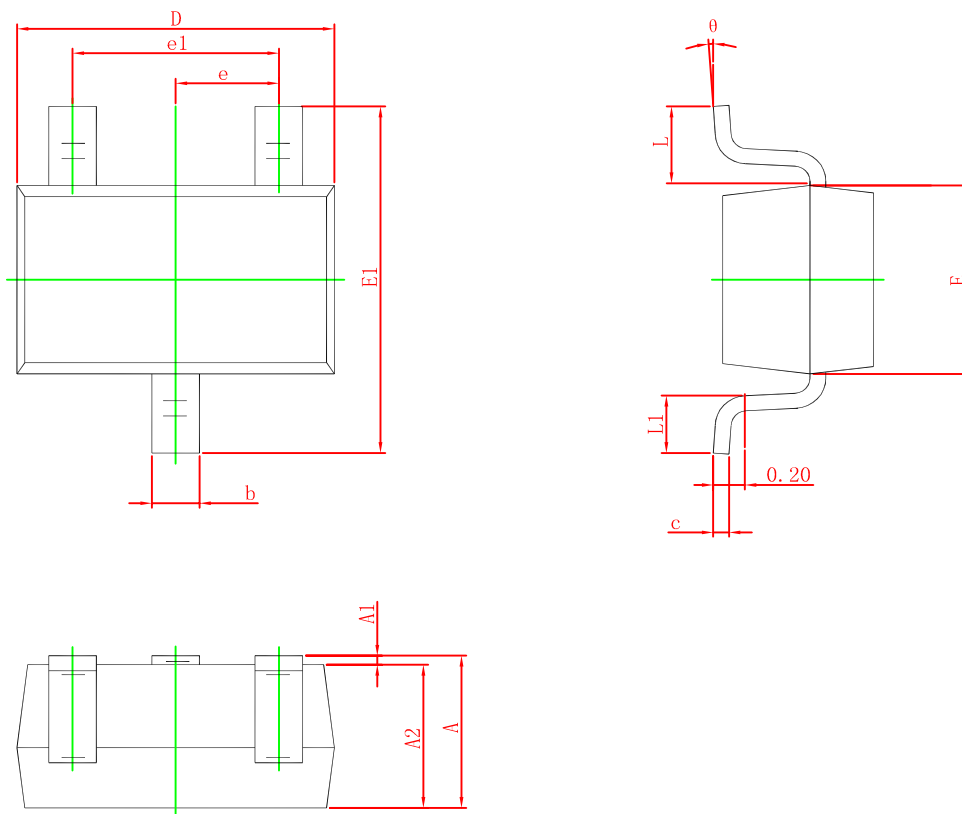

Symbol	Dimensions In Millimeters		Dimensions In Inches	
	Min.	Max.	Min.	Max.
A	0.900	1.100	0.035	0.043
A1	0.000	0.100	0.000	0.004
A2	0.900	1.000	0.035	0.039
b	0.200	0.400	0.008	0.016
c	0.080	0.150	0.003	0.006
D	2.000	2.200	0.079	0.087
E	1.150	1.350	0.045	0.053
E1	2.150	2.450	0.085	0.096
e	0.650 TYP.		0.026 TYP.	
e1	1.200	1.400	0.047	0.055
L	0.525 REF.		0.021 REF.	
L1	0.260	0.460	0.010	0.018
θ	0°	8°	0°	8°